

DETAILS

**PHENOLIC
TYPICAL IN-CORNER
LAYOUTS
6.0**

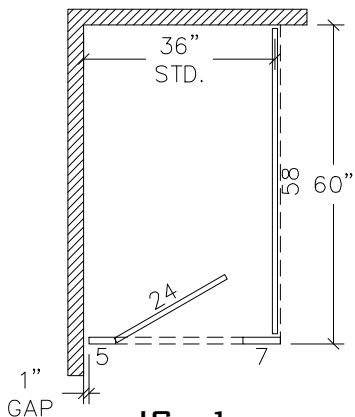

**IC - 1
STANDARD
CONFIGURATION**

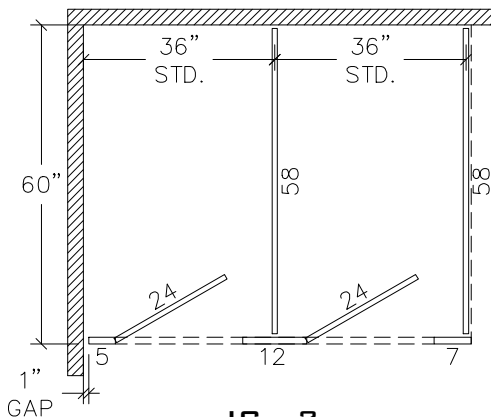

**IC - 2
STANDARD
CONFIGURATION**

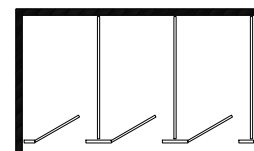

IC-3

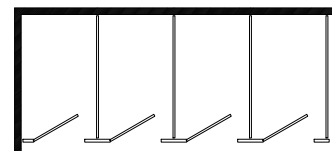

IC-4

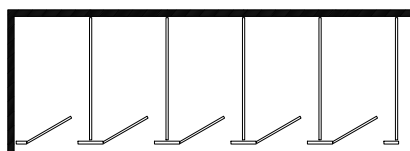

IC-5

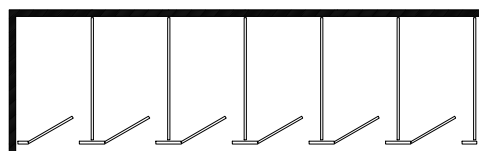

IC-6

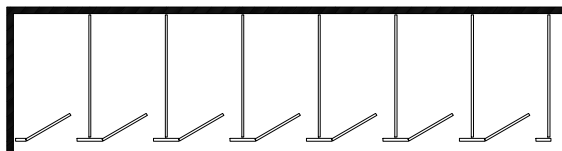

IC-7

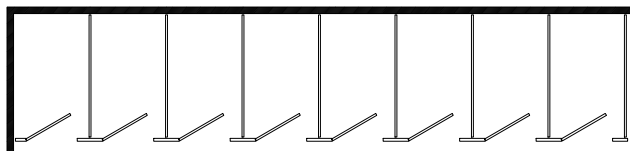

IC-8

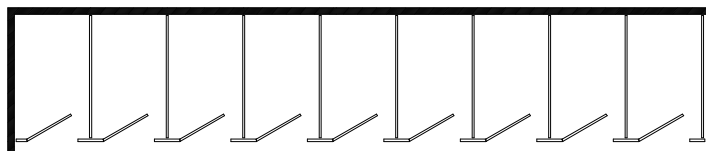

IC-9

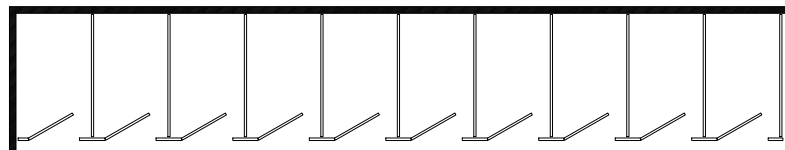

IC-10

REV 5/13